



Pb Free

Specification

SSC-LCW100Z1

(Rev. 3.3 - 101123)

Rev. 3.3

November 2010

WWW.SEOULSEMICON.COM

서식번호 : SSC-QP-7-07-25 (Rev.0.0)

[Contents]

1. **Description**
2. **Absolute maximum ratings**
3. **Electro-optical characteristics**
4. **Electro-Optical characteristic diagram**
5. **Reliability Test**
6. **Binning & Labeling**
7. **Outline Dimension**
8. **Reel Structure**
9. **Packing**
10. **Soldering profile**
11. **Precaution for Use**

SSC-LCW100Z1

SSC-LCW100Z1

1. Description

- Small size suitable for compact appliances.
- Surface-mounted chip LED device.
- Pb-free and RoHS complaint component.
- High brightness, High efficiency
- Tape and Reel packing.
- Increases the life time of battery.



Features

- 3.5 X 2.8 X 1.6 mm
- Emitted Color : White
- CIE chromaticity

x : 0.33	y : 0.34
x : 0.37	y : 0.37
x : 0.44	y : 0.41

Material : InGaN

Applications

- Array lighting
- Other decoration lighting
- Information Boards
- Lighting for Small Size Device.

2. Absolute maximum ratings

(Ta=25°C)

Parameter	Symbol	Value	Unit
Power Dissipation	P_d	175	mW
Forward Current	I_F	50	mA
Peak Forward Current	I_{FM}^{*1}	60	mA
ESD Sensitivity	HBM	10,000	V
Operation Temperature	$T_{opr.}$	-30 ~ 85	°C
Storage Temperature	$T_{stg.}$	-40 ~ 95	°C
Junction Temperature	T_j	115	°C

*1 I_{FM} conditions: Pulse width $T_w \leq 1$ msec and Duty ratio $\leq 1/10$.

3. Electro-Optical Characteristics

(Ta=25°C)

Parameter-	Symbol	Condition	Min	Typ	Max	Unit	
Forward Voltage	V_F	$I_F=20$ mA	2.7	3.1	3.7	V	
Zener Forward Voltage	$V_{F(z)}$	$I_F=5$ mA	0.6	0.8	1.5	V	
Color Temperature	CCT	$I_F=20$ mA	2600	-	8200	K	
4,700 K ~ 8,200 K	Luminous Intensity	I_v	$I_F=20$ mA	1270	2100	-	mcd
	Luminous Flux*2	Φ_v	$I_F=20$ mA	4	6.6	-	lm
	CRI	Ra	$I_F=20$ mA	70	75	80	-
2,600 K ~ 4,700 K	Luminous Intensity	I_v	$I_F=20$ mA	1270	1700	-	mcd
	Luminous Flux*2	Φ_v	$I_F=20$ mA	4	5.4	-	lm
	CRI	Ra	$I_F=20$ mA	75	80	90	-
Viewing Angle*3	$2\theta_{1/2}$	$I_F=20$ mA	-	120	-	°	
Thermal Resistance	$R\theta_{(J-S)}$	$I_F=20$ mA	57			°C/W	

*2 Φ_v is total luminous flux output as measured with an integrating sphere.

*3 $\theta_{1/2}$ is the off-axis where the luminous intensity is 1/2 the peak intensity.

[Note] All products confirm to the listed minimum and maximum specifications for electric and optical characteristics, when operated at 20mA within the maximum ratings shown above. All measurements were made under the standardized environment of SSC.

(Tolerance : $I_v \pm 10\%$, color coordinate 0.01, $V_F \pm 0.1$ V)

Rev. 3.3

November 2010

WWW.SEOULSEMICON.COM

서식번호 : SSC-QP-7-07-25 (Rev.0.0)

4. Electro-Optical Characteristic Diagram

Ta = 25°

Forward Current vs. Forward Voltage

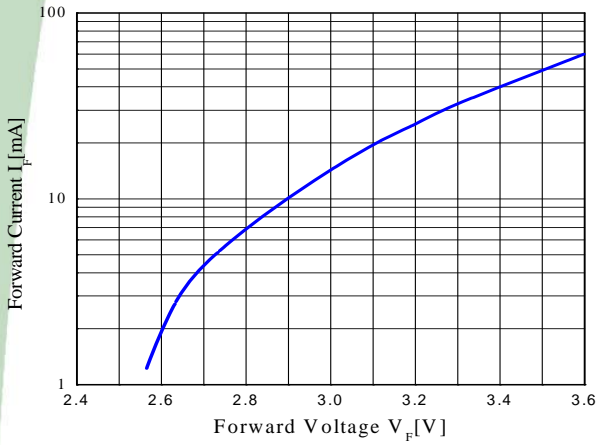

Relative Luminous Flux vs. Forward Current

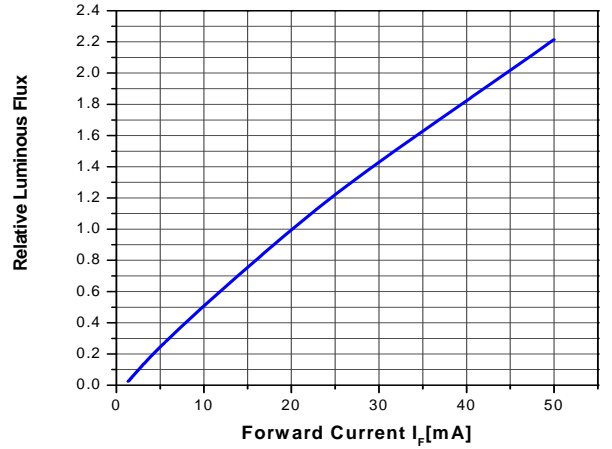

Relative Light Output vs. Junction Temperature at IF=20mA

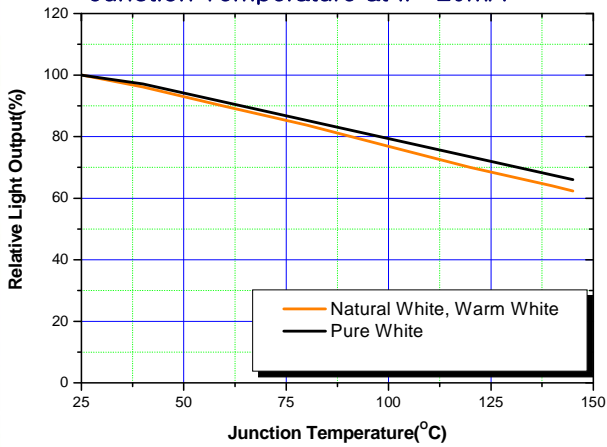

Ambient Temperature vs Allowable Forward Current

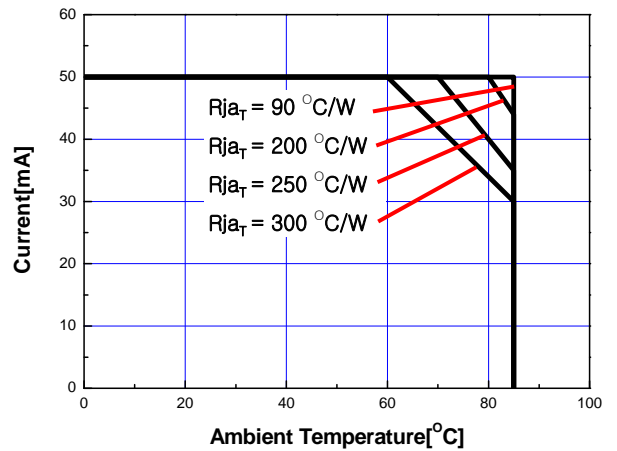

Radiation Diagram

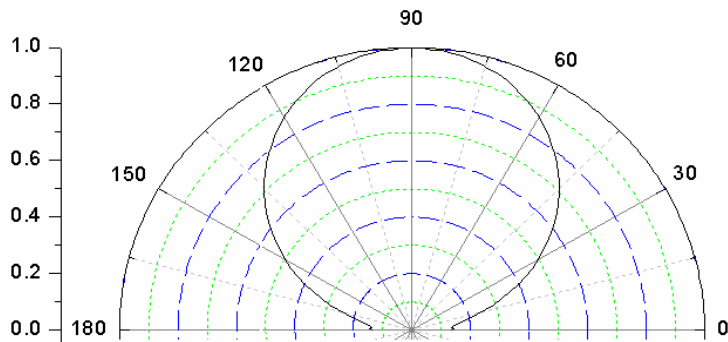

Spectrum Distribution

1. 4700K ~ 8200K

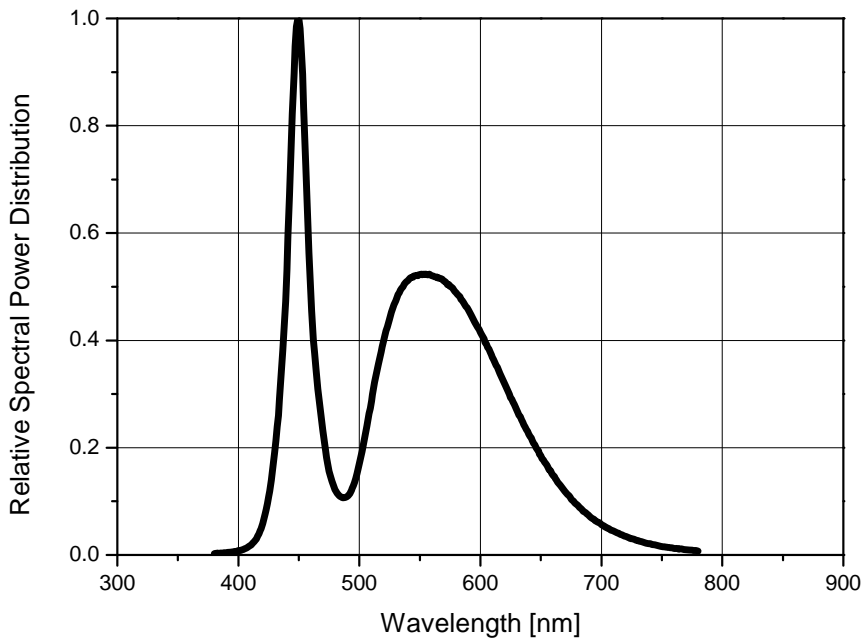

2. 2600K ~ 4700K

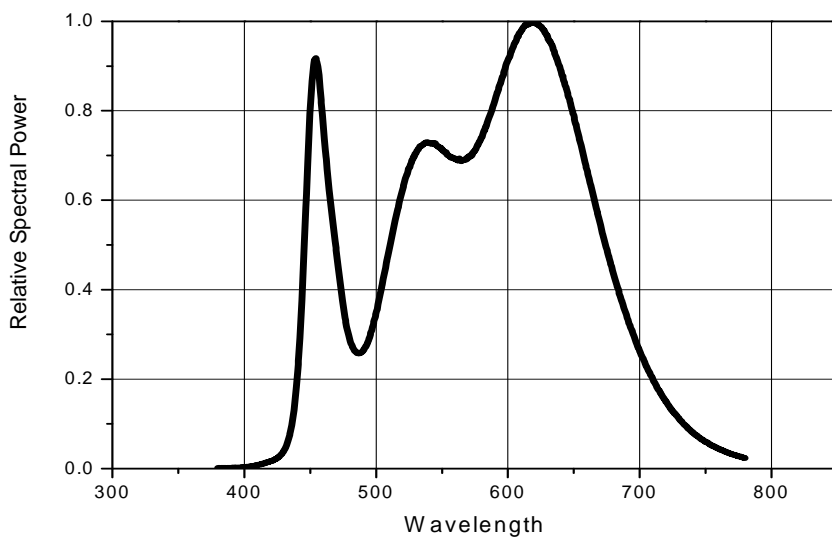

5. Reliability Test

Item	Test Conditions	Duration / Cycle	Number Of Damaged
Thermal Shock	$T_a = -40^{\circ}\text{C}$ (1 hour) ~ 85°C (1 hour)	100 Cycle	0/22
Thermostable	$T_a = 85^{\circ}\text{C}$, RH = 85% (24 hours Storage) → Reflow 3 cycle → Thermal Shock 30 Cycle		0/22
High Temperature Storage	$T_a = 85^{\circ}\text{C}$	1000 Hours	0/22
High Temp. High Humidity Storage	$T_a = 85^{\circ}\text{C}$, RH = 85%	1000 Hours	0/22
Low Temperature Storage	$T_a = -40^{\circ}\text{C}$	1000 Hours	0/22
High Temp. High Humidity Life Test	$T_a = 60^{\circ}\text{C}$, RH = 90%, $I_F = 20\text{mA}$	1000 Hours	0/22
High Temperature Life Test	$T_a = 85^{\circ}\text{C}$, $I_F = 20\text{mA}$	1000 Hours	0/22

6. Binning & Labeling

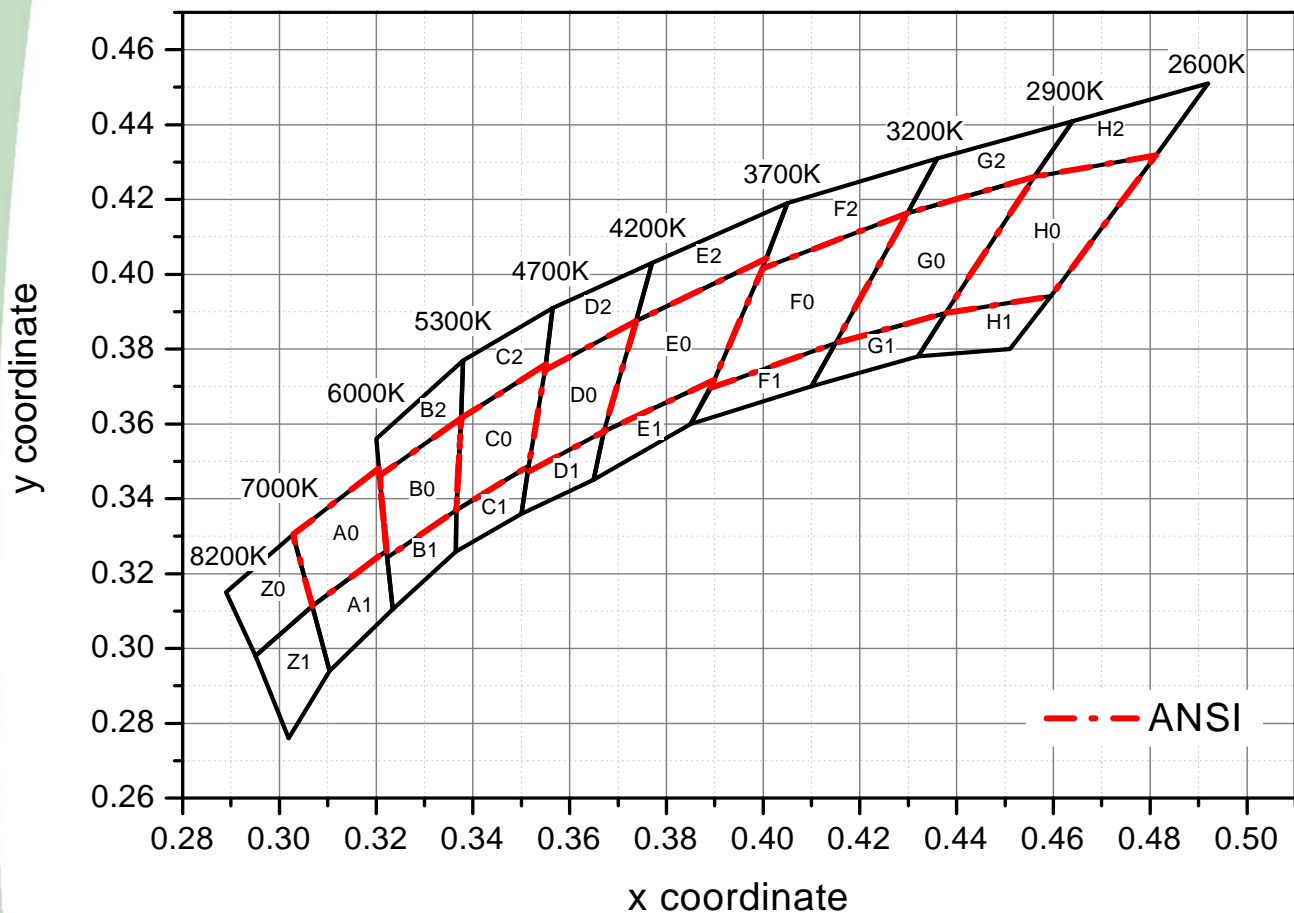

(1) Color Coordinate : x, y

<IF=20mA, Ta=25°C>

8200~7000 K				7000~6000 K			
Z0		Z1		A0		A1	
x	y	x	y	x	y	x	y
0.2950	0.2980	0.3019	0.2760	0.3205	0.3481	0.3068	0.3113
0.2890	0.3150	0.2950	0.2980	0.3028	0.3304	0.3221	0.3261
0.3028	0.3304	0.3068	0.3113	0.3068	0.3113	0.3234	0.3105
0.3068	0.3113	0.3104	0.2940	0.3221	0.3261	0.3104	0.2940

6000~5300 K					
B0		B1		B2	
x	y	x	y	x	y
0.3376	0.3616	0.3222	0.3243	0.3376	0.3616
0.3207	0.3462	0.3234	0.3105	0.3380	0.3770
0.3222	0.3243	0.3365	0.3258	0.3200	0.3560
0.3366	0.3369	0.3366	0.3369	0.3207	0.3462

5300~4700 K					
C0		C1		C2	
x	y	x	y	x	y
0.3551	0.3760	0.3365	0.3258	0.3565	0.3910
0.3376	0.3616	0.3366	0.3369	0.3551	0.3760
0.3366	0.3369	0.3515	0.3487	0.3376	0.3616
0.3515	0.3487	0.3500	0.3360	0.3380	0.3770

4700~4200 K					
D0		D1		D2	
x	y	x	y	x	y
0.3737	0.3875	0.3513	0.3471	0.3737	0.3875
0.3549	0.3743	0.3500	0.3360	0.3770	0.4030
0.3513	0.3471	0.3650	0.3450	0.3565	0.3910
0.3671	0.3580	0.3671	0.3580	0.3549	0.3743

4200~3700 K					
E0		E1		E2	
x	y	x	y	x	y
0.4007	0.4043	0.3650	0.3450	0.4050	0.4190
0.3737	0.3875	0.3671	0.3580	0.4007	0.4043
0.3671	0.3580	0.3898	0.3716	0.3737	0.3875
0.3900	0.3718	0.3850	0.3600	0.3770	0.4030

3700~3200 K					
F0		F1		F2	
x	y	x	y	x	y
0.4298	0.4163	0.3892	0.3695	0.4298	0.4163
0.3998	0.4015	0.3850	0.3600	0.4360	0.4310
0.3892	0.3695	0.4100	0.3700	0.4050	0.4190
0.4150	0.3816	0.4150	0.3816	0.3998	0.4015

3200~2900 K					
G0		G1		G2	
x	y	x	y	x	y
0.4560	0.4260	0.4100	0.3700	0.4640	0.4410
0.4298	0.4163	0.4150	0.3816	0.4560	0.4260
0.4150	0.3816	0.4377	0.3896	0.4298	0.4163
0.4377	0.3896	0.4320	0.3780	0.4360	0.4310

2900~2600K					
H0		H1		H2	
x	y	x	y	x	y
0.4812	0.4318	0.4377	0.3896	0.4812	0.4318
0.4560	0.4260	0.4320	0.3780	0.4920	0.4510
0.4377	0.3896	0.4510	0.3800	0.4640	0.4410
0.4595	0.3942	0.4595	0.3942	0.4560	0.4260

(2) Luminous Intensity : LI [mcd] / Luminous Flux: LF [lm]

Rank	IV [mcd]	LF [lm]	Condition
A	1270~1590	4.0~5.0	20mA
B	1590~1910	5.0~6.0	
C	1910~2230	6.0~7.0	
D	2230~2550	7.0~8.0	

(3) Forward Voltage: V_F [V]

Rank	V_F [V]	Condition
A	2.70~2.95	20mA
B	2.95~3.20	
C	3.20~3.45	
D	3.45~3.70	

(4) Labeling

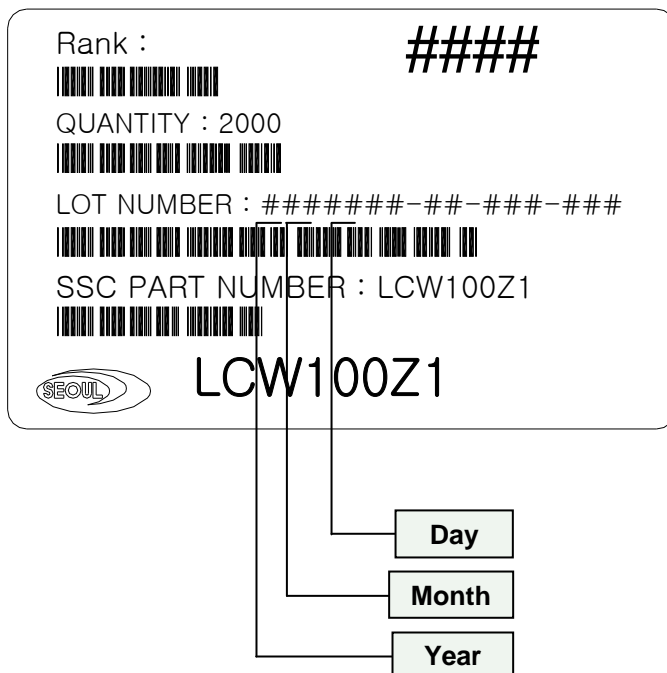

(5) Rank

#1#2#3#4

- #1 : Luminous Intensity : LI [mcd] / Luminous Flux : LF [lm]
- #2#3 : Color Coordinates : x, y
- #4 : Forward Voltage : V_F [V]

7. Outline Dimension

Tolerance: ± 0.1 , Unit: mm

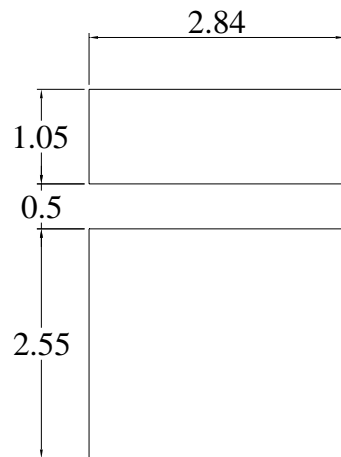
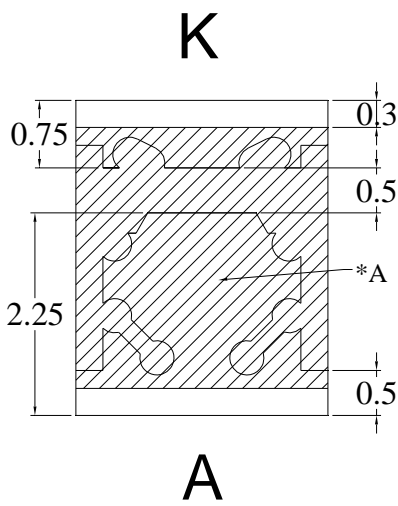
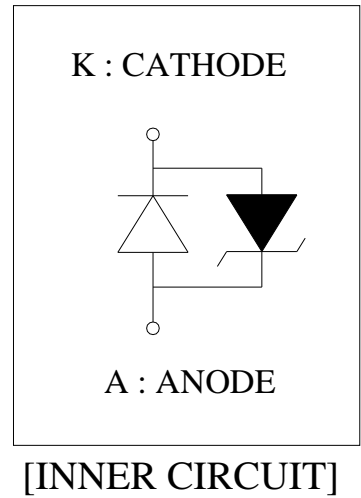
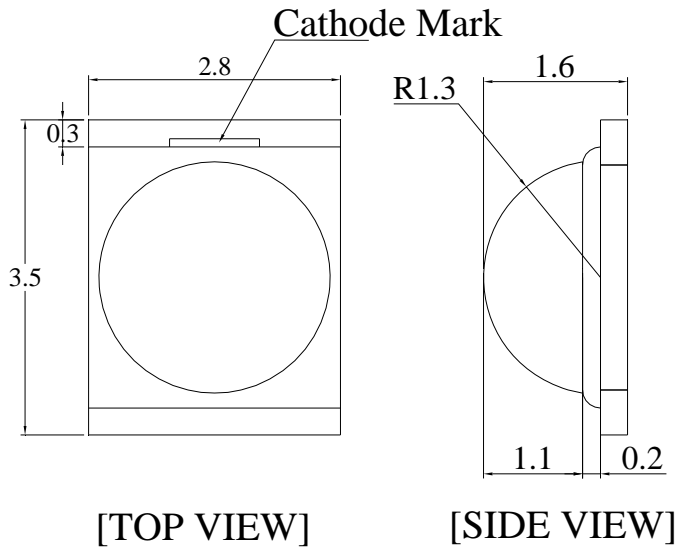

*A : This area can be covered with thin resin.

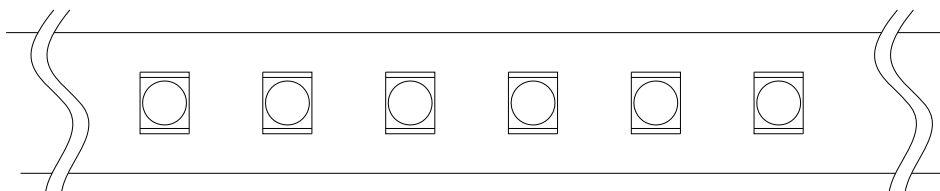

8. Reel Structure

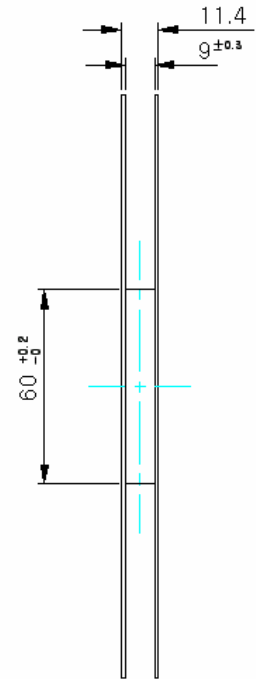
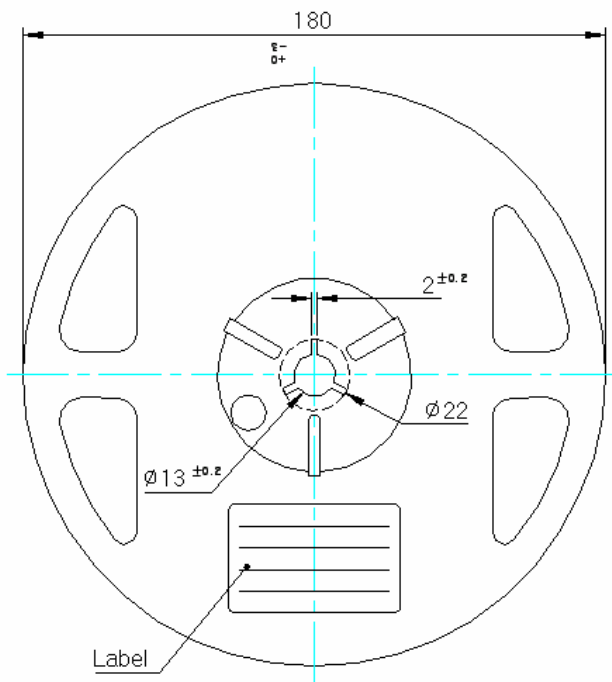
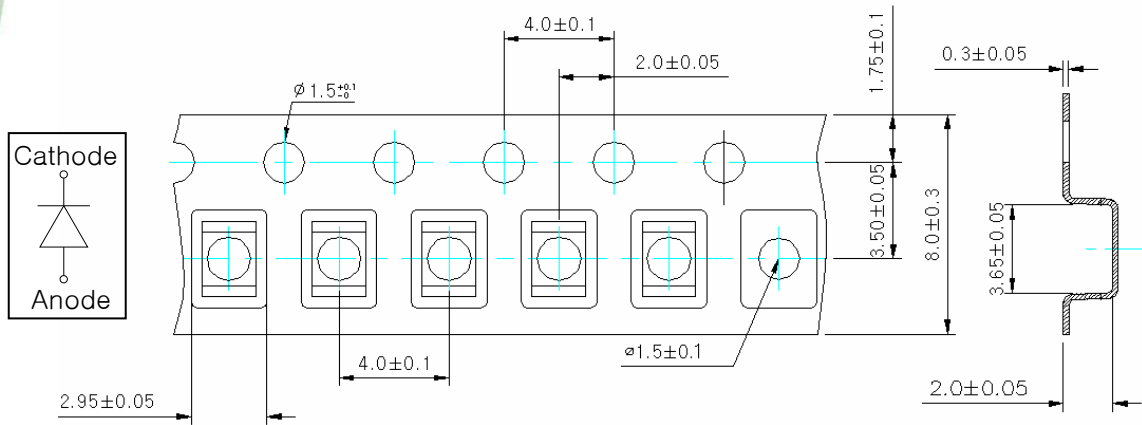

Tolerance: ± 0.2 , Unit: mm

- (1) Quantity: 2,000pcs./Reel
- (2) Cumulative Tolerance: Cumulative Tolerance/10pitches to be ± 0.2 mm
- (3) Adhesion Strength of Cover Tape: Adhesion strength to be 0.1-0.7N when the over tape is turned off from the carrier tape at 10° angle to be the carrier tape.
- (4) Package: P/N, Manufacturing data Code No. and quantity to be indicated on a damp proof Package.

9. Packing

Reel

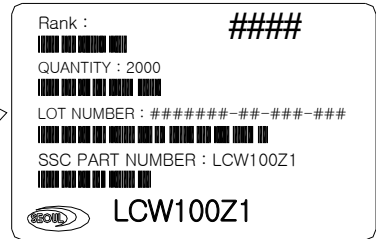
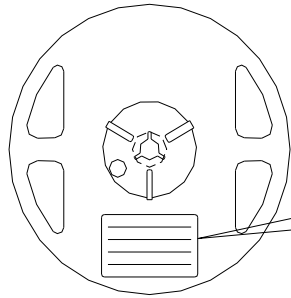

Aluminum Vinyl Bag

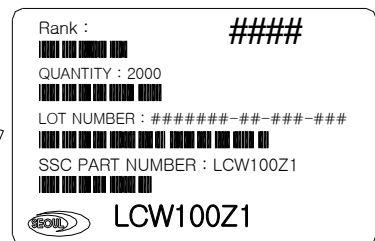
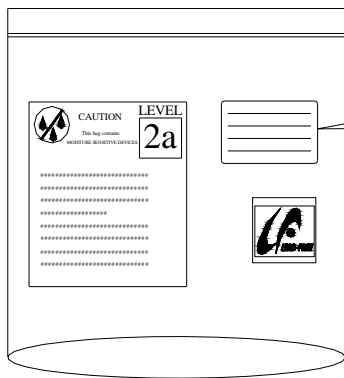

Outer Box

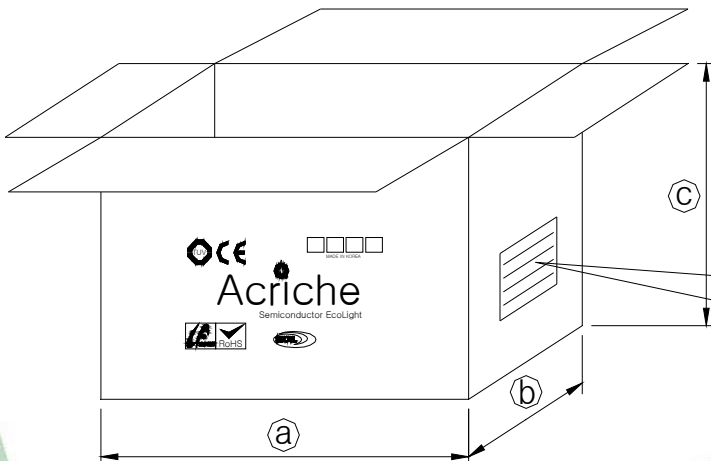

*Material : Paper (SW3B(B))

TYPE	SIZE(mm)		
	Ⓐ	Ⓑ	Ⓒ
7 inch	245	220	142

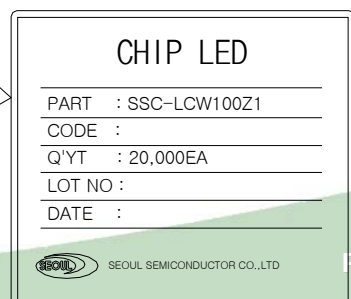

Rev. 3.3

November 2010

WWW.SEOULSEMI.CON.COM

10. Soldering profile

(1) Lead Solder

Lead Solder	
Pre-heat	120 ~ 150 °C
Pre-heat time	120 sec. Max.
Peak-Temperature	240 °C Max.
Soldering time Condition	10 sec. Max.

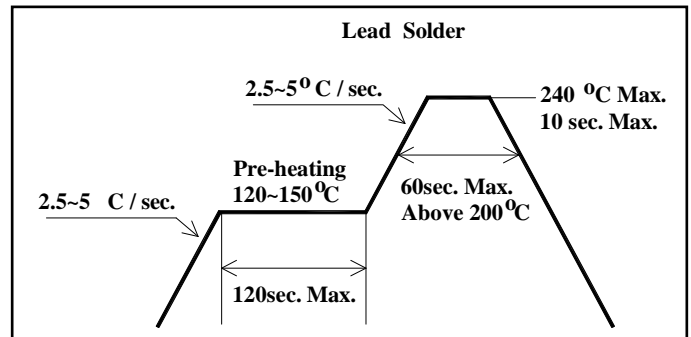

(2) Lead-Free Solder

Lead Free Solder	
Pre-heat	150 ~ 200 °C
Pre-heat time	120 sec. Max.
Peak-Temperature	260 °C Max.
Soldering time Condition	10 sec. Max.

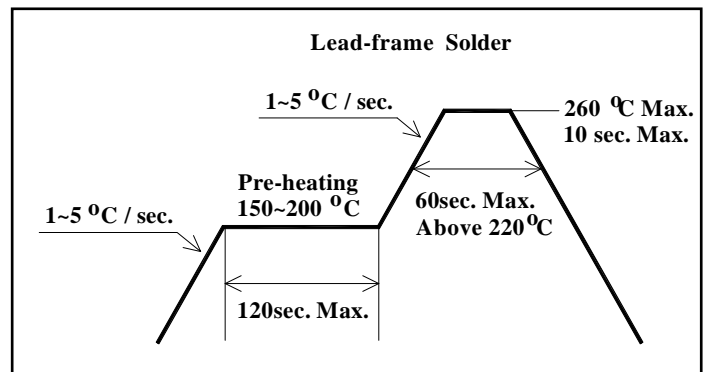

(3) Hand Soldering conditions

Do not exceed 1 second at maximum 280 °C under soldering iron.

(4) The encapsulated material of the LEDs is silicone.

Precautions should be taken to avoid the strong pressure on the encapsulated part.

So when using the chip moulder, the picking up nozzle that does not affect the silicone resin should be used.

Note : In case that the soldered products are reused in soldering process, we don't guarantee the products.

11. Precaution for Use

1. Storage

To avoid absorption of moisture, it is recommended to store parts in a dry box (or desiccator) with a desiccant. Otherwise, storage in the following environment is recommended.

※ Temperature : 5°C~30°C Humidity : 60%HR max.

2. Parts stored more than four weeks after opening or if desiccant indicator shower color changes, it is highly recommended that LED's should be baked for 10 ~ 12 hours at 60°C±5°C
3. LEDs must be stored at clean atmosphere. If the LEDs are stored for 3 months or more after shipment from SSC, storage in a sealed container with a nitrogen is recommended.
4. If the LED is considered to be wet, it is highly recommended that the LED should be dried for 100Hr at 80±5°C or 12Hr at 100±5°C.
5. Any mechanical force or excess vibration should be avoided during temperature cooling process to normal temperature after reflow.
6. Rapid cooling should be avoided
7. LED should not be placed on a flexible area of the PCB
8. This device should not be used in any type of fluid such as water, oil, organic solvent and etc. When washing is required, IPA should be used.
9. When the LED is operating in DC mode, the driving current should be determined after considering the thermal properties of the application and maximum ambient temperature requirements.
10. Damage prevention from ESD or Surge.
 - ☞ It is highly recommended to use the wrist-band or anti electrostatic gloves when handling the LED's
 - ☞ All devices, equipments and machines must be properly grounded