

ROCKER SWITCHES

SERIES RA1066

RA 1066

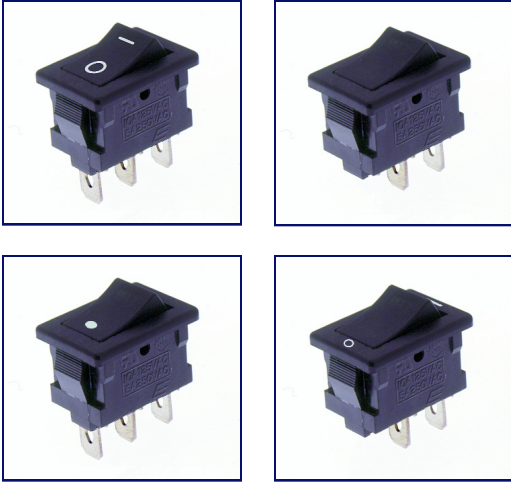

SPECIFICATIONS

CONTACT RESISTANCE: 100m max.

DIELECTRIC STRENGTH: AC2000V for 1 minute

LIFE EXPECTANCY: Electrical/10,000 cycle (R-L o a d)
Mechanical/25,000 cycle

RATING: 10A 125 VAC / 5A 250 VAC

OPERATING FORCE: 400±200gf

SAFETY STANDARD APPROVAL: UL (JRA), CSA, VDE, NEMKO,
SEMKO, FIMKO, DEMKO

MATERIALS

CONTACTS: Silver plated copper alloy



HOW TO ORDER

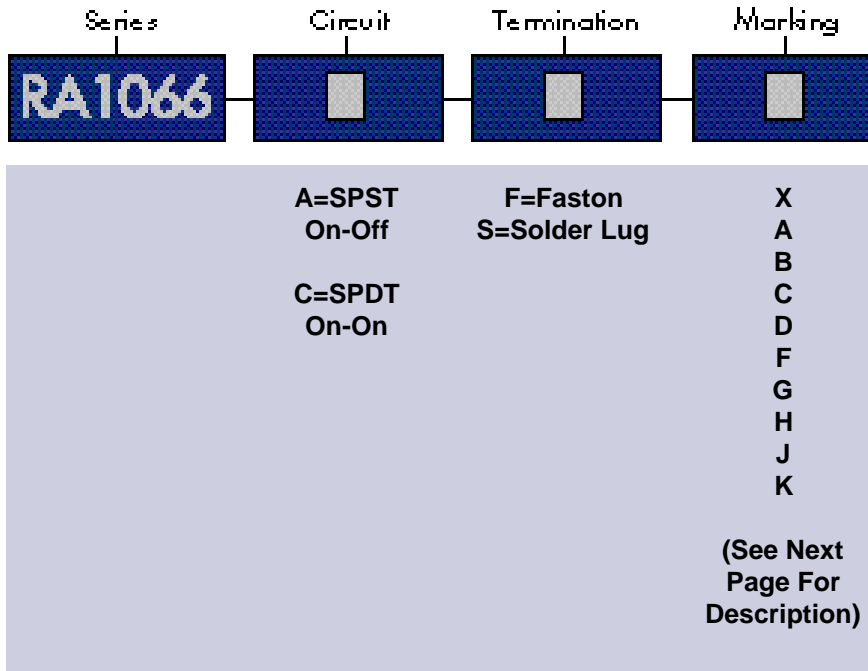

Example:

RA1066 → A → F → H

SPECIFICATIONS SUBJECT TO CHANGE WITHOUT NOTICE.

A SPST

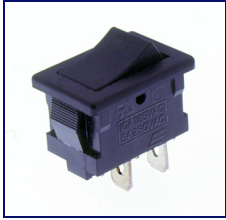

Circuit Code	POS 1	POS 2
A	ON	OFF
Term. Comm.	2-1	OPEN

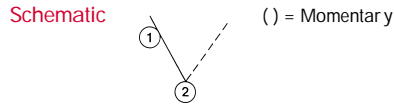

C SPDT

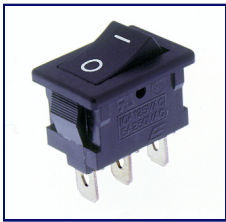

Circuit Code	POS 1	POS 2
C	ON	ON
Term. Comm.	2-1	2-3

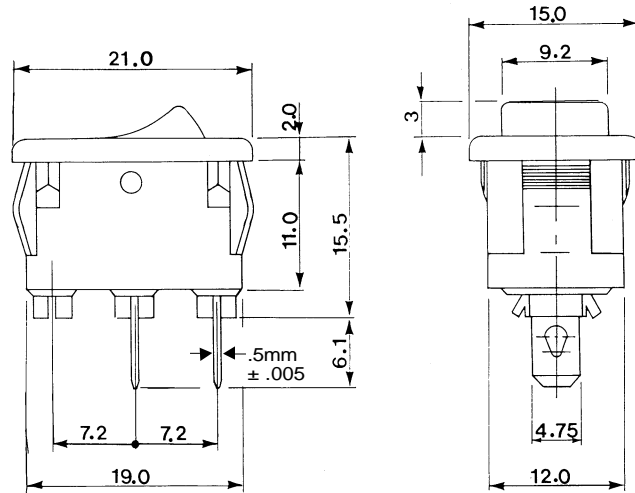
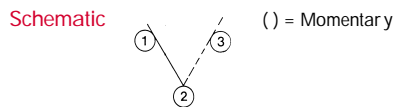

All dimensions in mm.

PANEL MOUNTING

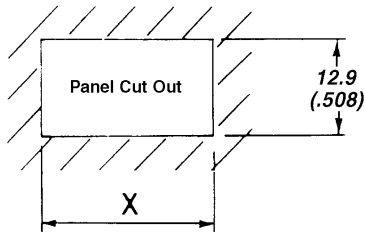

Panel Thickness	'X' Dim.
.75 - 1.25 (.030)-(.049)	19.2 (.756)
1.25 - 2.00 (.049)-(.079)	19.4 (.764)

TERMINATION OPTIONS

F Faston

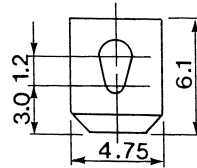

S Solder Lug

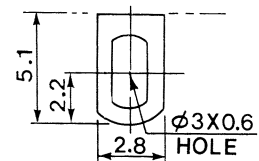

0.508 (.020) THK terminals designed for Quick Connect connectors available from AMP Industries, Harrisburg, PA 17105. (Or equivalent).

(F) Termination Rating:
10A, 125VAC

(S) Termination Rating:
5A, 250V AC

MARKING OPTIONS

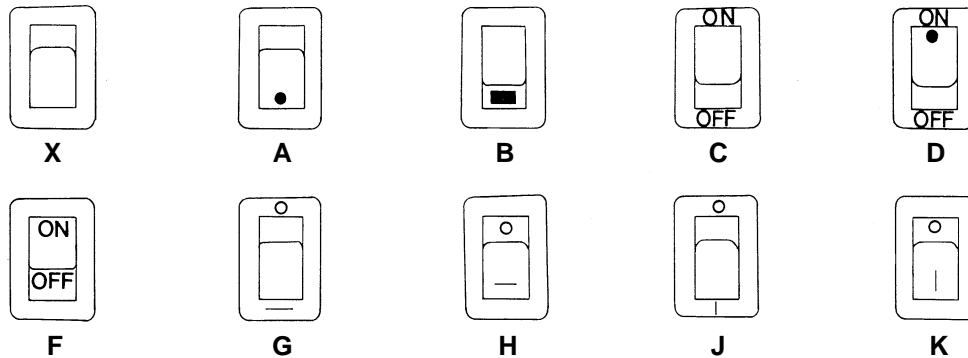

SPECIFICATIONS SUBJECT TO CHANGE WITHOUT NOTICE.